

# **ORTEC<sup>®</sup>**

## ***Micro-UF6-STFC***

Portable UF6 Cylinder Verification System



**AMETEK<sup>®</sup>**  
ADVANCED MEASUREMENT TECHNOLOGY

# Micro-UF6-STFC

- **UF6-STFC cylinder verification system** implemented on a special ORTEC Micro-trans-SPEC HPGe Portable Spectrometer with a reinforced structural frame and a Stable, Thin Front Contact on the detector to eliminate in-growth of a dead layer over time.
- **All-in-one instrument** with software designed to follow the current procedures for UF6 cylinder inspection by safeguards inspectors.
- **High precision, rapid results** through combining tried-and-tested methodology with the latest advances in HPGe spectrometry.
- **Solves spectral interference problems** encountered with NaI-based systems.
- **Micro-trans-SPEC hardware** can be used for other related applications.
- Operating time of up to 5 hours on a single battery.
- “Snap-open” battery door for rapid battery exchange with minimal down-time.
- New improved silent running, low-power cryocooler.

The ORTEC Micro-trans-SPEC is a field deployable LN<sub>2</sub>-free HPGe spectrometer. The Micro-trans-SPEC, weighing in at less than 7 kg (excluding additional hardware such as collimators), is small and compact yet rugged enough for field operations.

The instrument features a long life Stirling cycle cryocooler and digital electronics. It can be powered from a variety of sources, including worldwide mains, automobile and other DC sources, which means it is ideal for safeguards inspections where an inspector may arrive at a facility with the instrument in the operational state and ready for use.

The Micro-UF6-STFC has a Stable, Thin Front Contact (STFC) which provides excellent gamma transmission at lower energies. This advanced contact design does not penetrate into the germanium crystal at room temperature, ensuring stable detector efficiency, even when stored warm. There is no in-growth of the dead layer over time that could reduce efficiency.

The internal battery provides up to 5 hours operational life and is easily replaced, minimizing down time. The powerful built-in data processing capabilities make it ideal for onboard custom data analysis, and the bright clear screen makes it a pleasure to use, even in bright outdoor conditions.



The snap-open battery compartment makes battery changing simple.

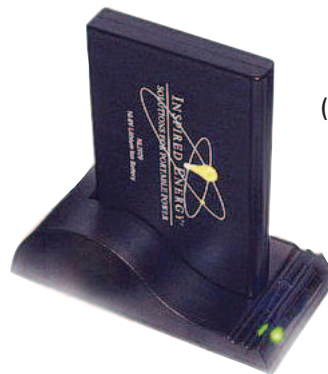

Desktop battery charger (MICRO-DET-ACC-CHGR). Recharges battery (MICRO-DET-ACC-BAT) in ~5 hours.

# Micro-UF6-STFC

## The UF6 Cylinder Verification System

For the UF6-STFC cylinder verification application, the Micro-trans-SPEC is supplied with a reinforced structural frame, a Stable, Thin Front Contact on the detector to eliminate in-growth of a dead layer over time, and a custom-designed tungsten collimator. (The collimator may be removed if not required).

The UF6 software application is based on the classical enrichment meter method and executes on the Micro-trans-SPEC without the need for the inspector to carry an extra computer.

The user interface is similar to the Micro-trans-SPEC basic GUI software and uses identical methods for such tasks as hardware setup and storage of spectra and display. In addition, many of the data entry fields are stored in a configuration file that may be created and edited on a 32-bit Windows 7 or Windows XP computer and subsequently copied to the built-in data processor using Windows Mobile Device Center or Microsoft ActiveSync.

The basic operation of the software is an automated sequential process of the following tasks:

- Acquire spectral data
- Store the data
- Analyze the data
- Report results to file and screen

Program operation is designed so that a minimal amount of information is required to acquire, store, analyze and report a finding.

Uranium enrichment is determined by a variation of the “classic” infinite thickness method.<sup>2</sup> Originally the method was developed for use with NaI(Tl) detectors and suffered from potential spectral interferences. Because an HPGe detector is used, the area of the 186 keV gamma-ray peak can be derived by a method less susceptible to interference from nearby peaks.

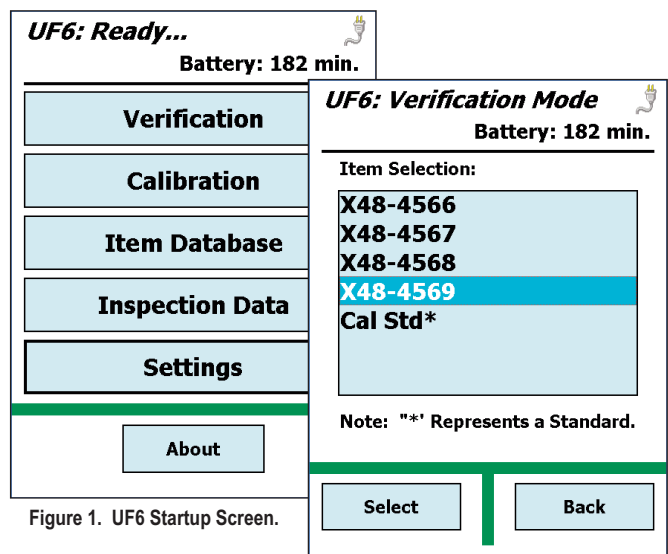

Figure 1. UF6 Startup Screen.

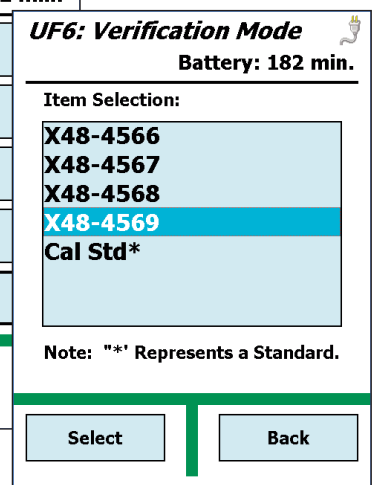

Figure 2. Verification Mode Item Selection.

## Operational Overview

The startup screen presents the inspector with a number of choices (Fig. 1). The first choice is Verification, which is the most simple inspection measurement when all other system parameters are set up.

The verification mode is composed of the following sequential steps:

- Select an Item ID from the Item Database,
- Enter the Inspection Data for the acquisition and analysis, including Background Correction method
- Acquire and Analyze data,
- Store results to a spectrum file and create an analysis report.

The Item Database is typically loaded before the start of the measurement program at the facility in question. It is a standard text file that may be edited on the PC using the Notepad application and transferred to the built-in data processor using the Windows Mobile Device Center or Microsoft ActiveSync. It can contain standards which may be used to check correct operation of the system.

The second step of the verification process is the entry of “bookkeeping data” (Fig. 3). This minimum set of data is required for each verification measurement. The count preset fields are initialized from default values, that are the last values used for the Verification mode acquisition. The wall thickness is also required and is entered via the keypad.

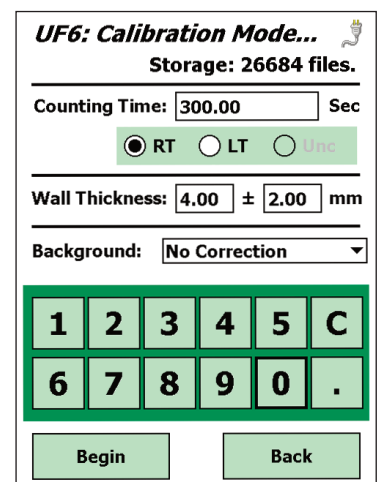

Figure 3. Verification Bookkeeping Data Entry.

<sup>2</sup>See for example “The Measurement of Uranium Enrichment” by Hastings Smith Jr., “Passive Nondestructive Assay of Nuclear Materials; Reilly D., Ensslin N., Smith H., and Kreiner LA-UR-90-732, ISBN 0-16-032724-5 (1991), Chapter 7.

# Micro-UF6-STFC

## Real Time Results

Once data acquisition has begun, the screen shown in figure 4 appears. This screen shows a portion of the spectrum (150 keV to 210 keV) with an ROI marked around the 185.7 keV peak. ROIs are also marked around the low and high background ROIs. During the acquisition, the ROIs, count rate, and enrichment results are periodically updated and displayed.

Both Atom% or Wt% displays are available.

## System Calibration

The Calibration mode is similar to the Verification mode, but the calibration constant is set based on expected results from a standard definition. It is composed of the following sequential steps:

- Select an Item ID Standard from the Item Database,
- Enter the Inspection Data for the acquisition and analysis,
- Acquire and calibrate from spectrum,
- Store the calibration constant to the Configuration File.

This Calibration interface also allows users to acquire background spectra, or evaluate new calibration data considering previously acquired background spectra.

## Item Database

The Item Database mode permits editing of the contents of the Item Database (Fig. 5). This includes modification, addition and deletion of items in the database. The Item Database is a standard text file (UF6.ISL) that is located in the Program Files\UF6 folder. The inspector may choose an existing Item ID for modification or deletion. (Note that the asterisk [\*] in the item selection list denotes a "standard" setting that may be used for calibration and validation of correct system operation.)

## Inspection Data

Inspection Data mode manages the Inspection Data file contents: inspector data, such as the inspector name, country codes, facility name, inspection number and other optional comments. The data file is a standard text file that may be edited on the PC and transferred to the built-in data processor using the Windows Mobile Device Center or Microsoft ActiveSync prior to starting the series of measurements. All data are stored in the Inspection Data file (UF6.IDB) that is located in the Program Files\UF6 folder.

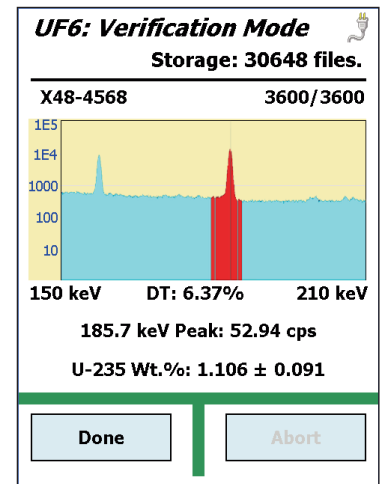

Figure 4. Real Time Enrichment Result Display.

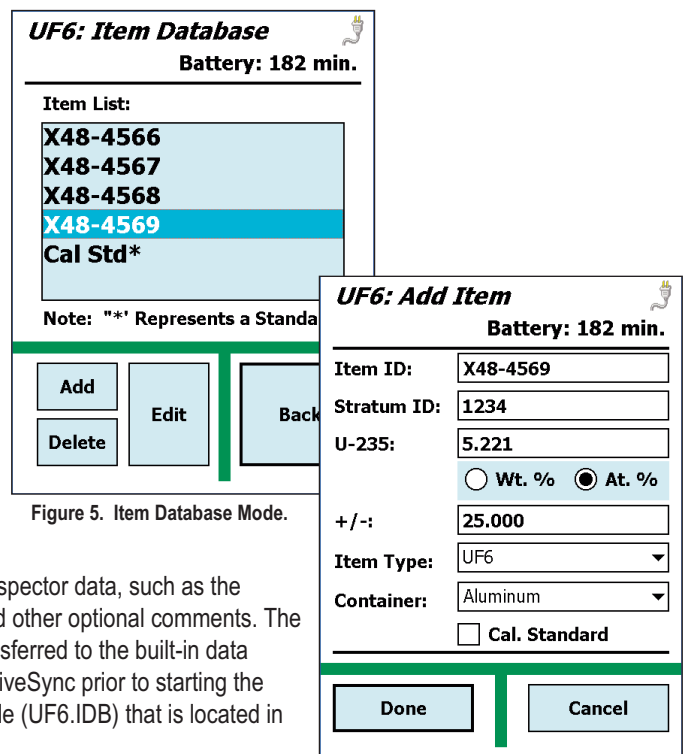

Figure 5. Item Database Mode.

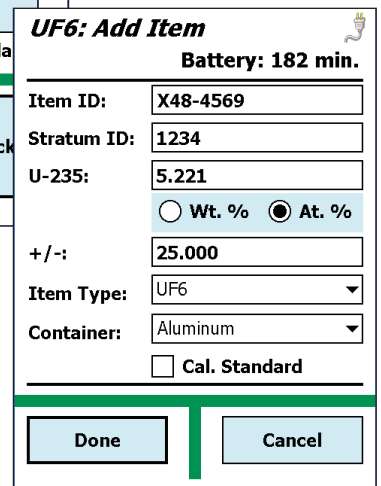

Figure 6. Item Database Edit.



# Micro-UF6-STFC

## Settings

The Settings mode manages the hardware settings of the instrument and includes hardware setup, cooler control, energy calibration, state-of-health, etc., all selectable from a single screen.

The energy calibration procedure (Fig. 8) is specific to the UF6 application. The hardware settings are adjusted to position the U-235 peak at 185.7 keV in channel 2476 as required by the method.

The Spectra option allows the user to define “bookkeeping” options such as where spectra are to be saved and if the user is to be asked for descriptive input on saving a file. A “recall mode” allows spectra to be retrieved for scrutiny in a convenient MCA display mode, reminiscent of the MAESTRO MCA display. Users may use MAESTRO to view spectra on a laptop once files have been transferred via the Windows Mobile Device Center or Microsoft ActiveSync. The MCA display mode features log/lin vertical scale, moveable cursor and zoom in/zoom out. The cursor position displays counts and energy (Fig. 9).

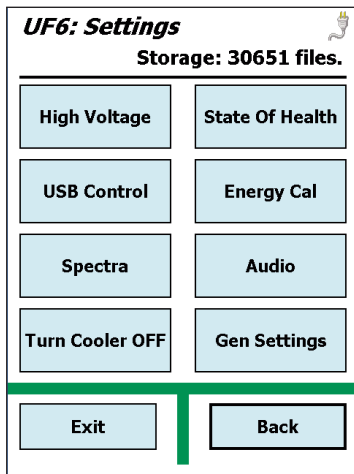

Figure 7. Settings Screen.

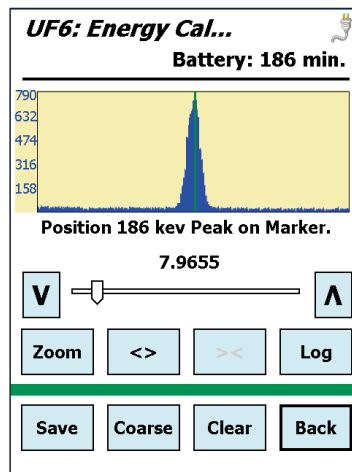

Figure 8. UF6 Energy Calibration.

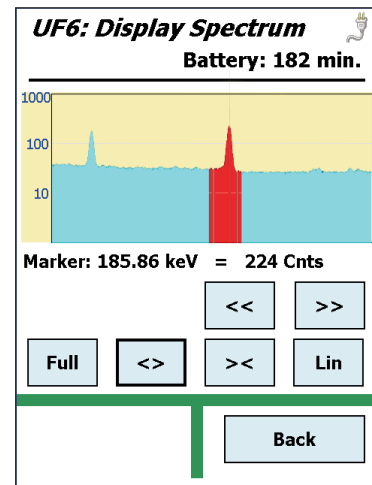

Figure 9. View Stored Spectra.

# Micro-UF6-STFC

## Special Micro-trans-SPEC Hardware Specifications Summary

- Light — 17 lb (7.7 kg). (Without collimator.)
- Tough — Enclosure, display, and all connections sealed against moisture and dust. Water spray resistant.
- High Sensitivity — 50 mm Ø x 40 mm HPGe Detector with a Stable, Thin Front Contact for better efficiency and better long term stability.
- High Stability — Digital electronics.
- Bright and Clear — VGA display with touch sensitive operator screen.
- High Speed USB, Wireless 802.11, GPS, and SD card storage of acquired spectra.
- Operates from quick-change internal battery for ~5 hours, or from external battery, automobile power, or line power.
- Latest generation miniature, high-efficiency, Stirling-cycle cooler; offers reduced levels of acoustic noise and vibration, and longer operational life. Detector element is sealed in a high-reliability, low-loss cryostat.

## Removable Collimator

The removable tungsten collimator has been designed to provide 99.999% absorption of gamma-rays below 200 keV from all directions (except the front field of view). This is accomplished by having a close fit of the collimator to the cryostat mount (in the rear of the detector) which eliminates any straight line of sight to the detector from all angles. This will reduce the background coming from the back and sides of the unit as well as the front. The entire inside surface facing the detector crystal has a graded-Z (copper/tin) liner to minimize the fluorescence spectrum from the tungsten, especially the 59 keV x-ray.

Removal of the collimator requires no tools, allowing the instrument to be configured for different measurements in the field. The collimator has mounted rubber spacers for improved measurement repeatability.

## Brief specifications of the built in data processor:

- Display: VGA 640 x 480 TFT sunlight readable touch-sensitive, operate with finger or stylus.
- Data Processor: Marvel PXA320 XScale 806 MHz.
- Memory: 128 MB DDR SDRAM.
- Data Storage (Spectra, results, etc.): Removable SD card and onboard nonvolatile Flash 1 MB, expandable to 2 GB.
- Computer Interfacing: USB connection to laptop.
- Spectral Transfer: Windows Mobile Device Center or Microsoft ActiveSync.
- Wi-Fi (802.11) communication software optionally available.

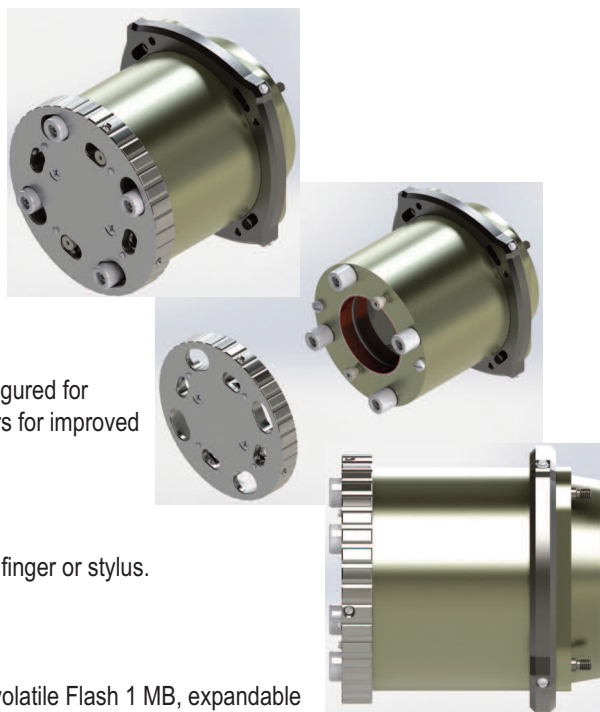

# Micro-UF6-STFC

## Ordering Information

### Model

MICRO-UF6-STFC-PKG-1

MICRO-DET-OPT-1

MICRO-DET-ACC-BAT

MICRO-DET-ACC-CHGR

### Description

Micro-trans-SPEC based Portable UF6 Cylinder Verification System.

Includes special Micro-Trans-SPEC with reinforced structural frame and a Stable, Thin Front Contact on the detector, removable graded tungsten collimator and case, wheeled waterproof transport case, and UF6 software.

Rugged, waterproof, wheeled transport case.

Lithium-ion battery.

Standalone battery charger and calibrator kit.

**Further battery charging and upgrade options are available.**



---

# *Micro-UF6-STFC*

---

Specifications subject to change  
040920

**ORTEC<sup>®</sup>**

***[www.ortec-online.com](http://www.ortec-online.com)***

Tel. (865) 482-4411 • Fax (865) 483-0396 • [ortec.info@ametek.com](mailto:ortec.info@ametek.com)  
801 South Illinois Ave., Oak Ridge, TN 37830 U.S.A.  
For International Office Locations, Visit Our Website

** AMETEK<sup>®</sup>**